

A	B	C (mm)	D	
1	L30-001	2040	450	5/5
2	L30-002	2040	450	5/5
3	L30-003	2040	450	5/5
4	L30-004	2040	450	5/5
5	L30-005	2040	450	5/5
6	L30-101	2080	585	1/5
7	L30-102	2080	585	1/5
8	L30-103	2044	556	2/5
9	L30-104	2044	556	2/5
10	L30-201	2406	615	3/5
11	L30-301	2274	556	3/5
12	L30-302	902	535	4/5
13	L30-304	438	535	4/5
14	L30-305	437	535	4/5
15	L30-401	2274	40	3/5
16	L30-901-01	2054	910	1/5
17	L30-902	2054	446	1/5
18	L30-903-01	2054	910	1/5
19	dr-897	897	30	4/5

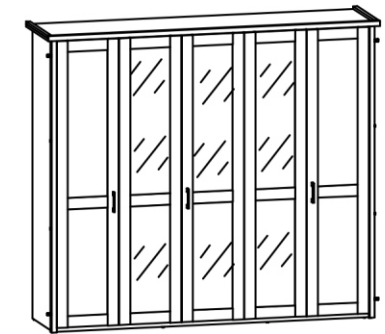

4x a101	6x a103	4x a43	6x a68	cm 0 1 2 3 4 5 6 7 8 9 10						10x b35	10x b59
3x c406 128 mm	12x d1 ∅5x17 mm	4x e22 ∅7x28 mm	16x f1 ∅8x30 mm	8x j8 M4x25 mm	8x k1	2x k39/2 M8/∅14x14 mm	2x k39/3 M8/22 mm	58x l2	4x n158	4x p1 ∅3,5x13 mm	
40x p51 ∅3,5x15 mm	24x r1 ∅15x12 mm #16	18x r36 ∅20x12 mm #16	18x r37	24x r42	1x z1	4x s1	24x s2 ∅16	5x d20	5x e2 ∅6,3x13 mm	8x d1 ∅5x17 mm	

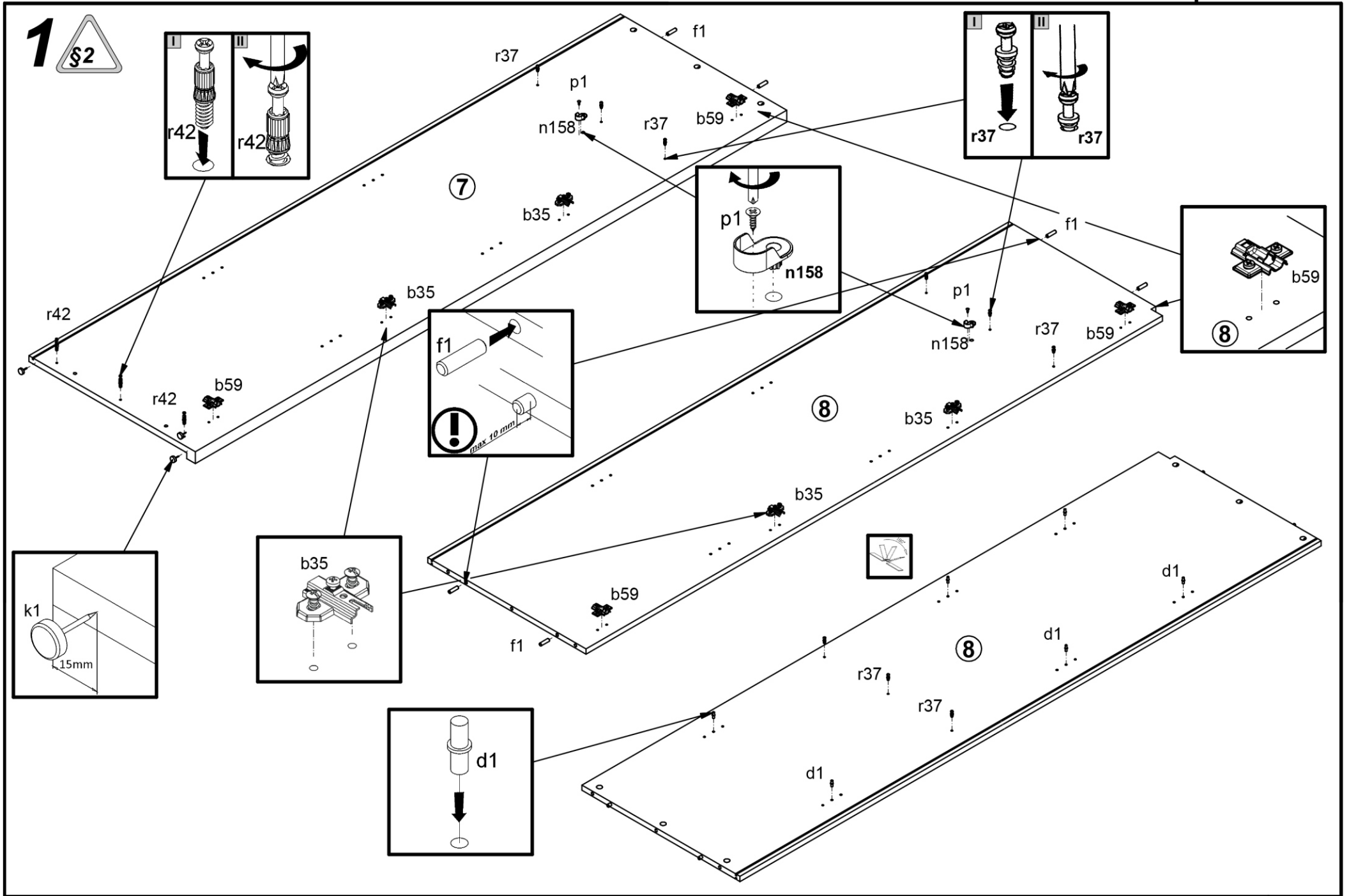



2

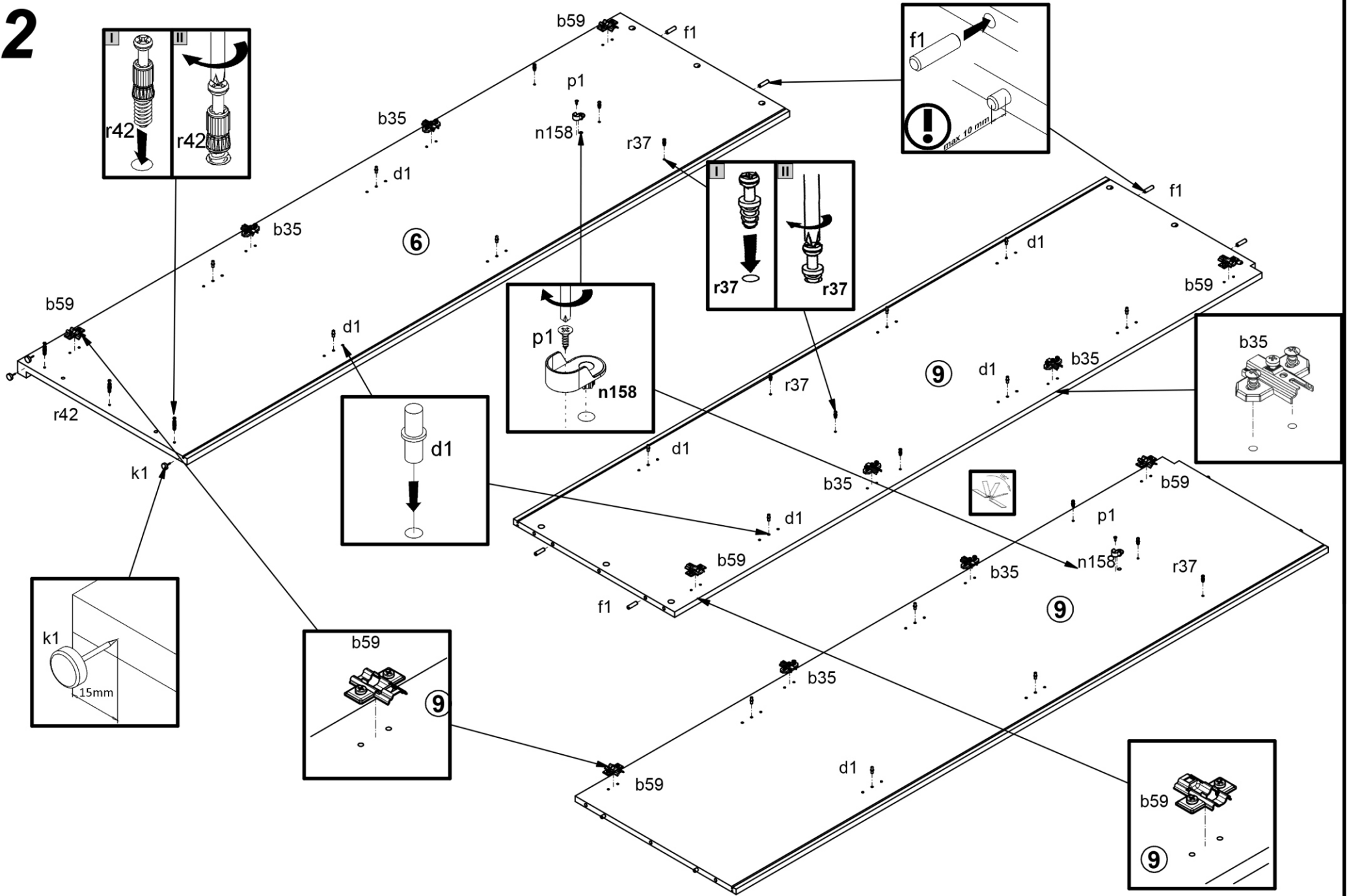

3

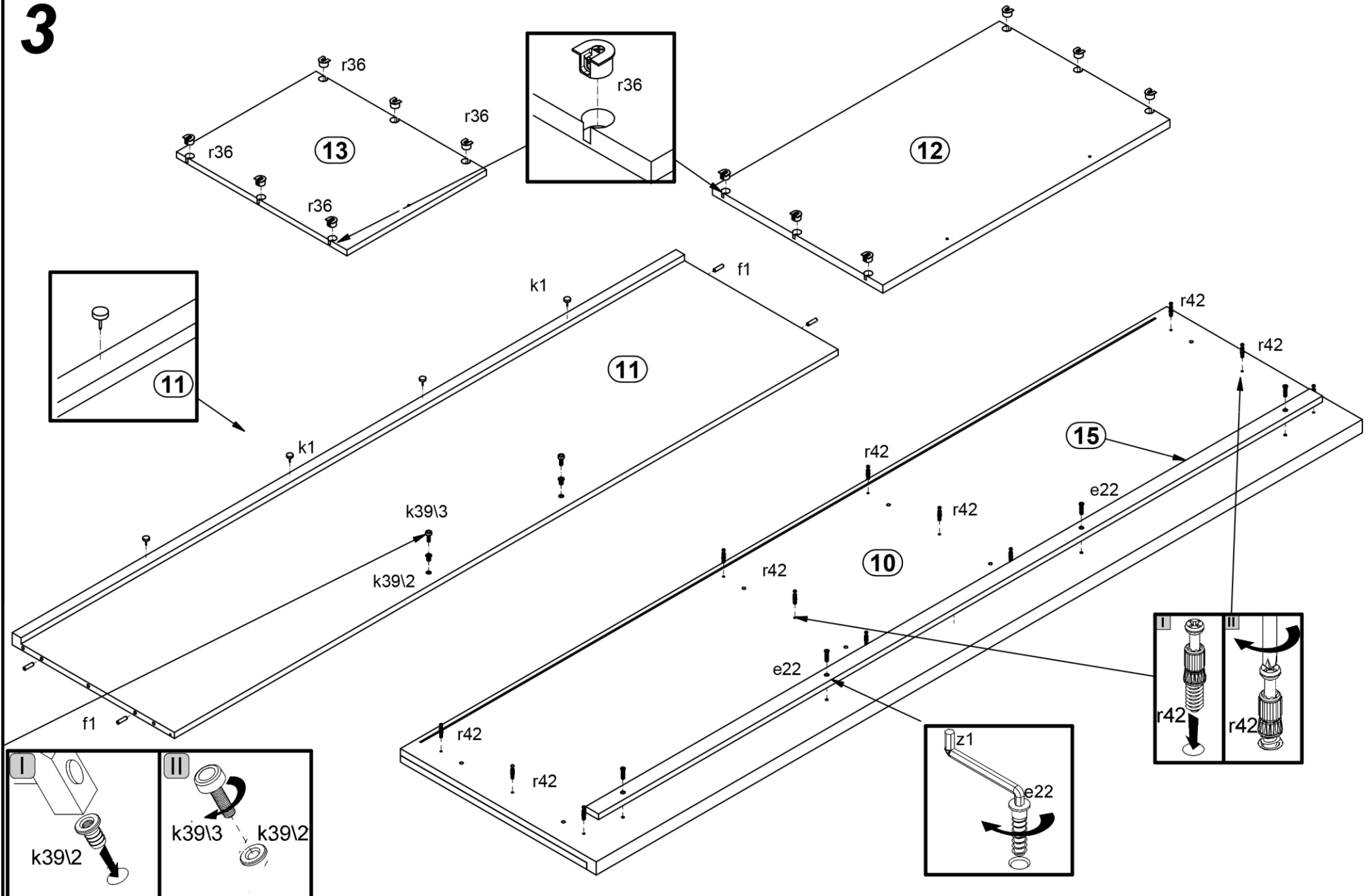

4

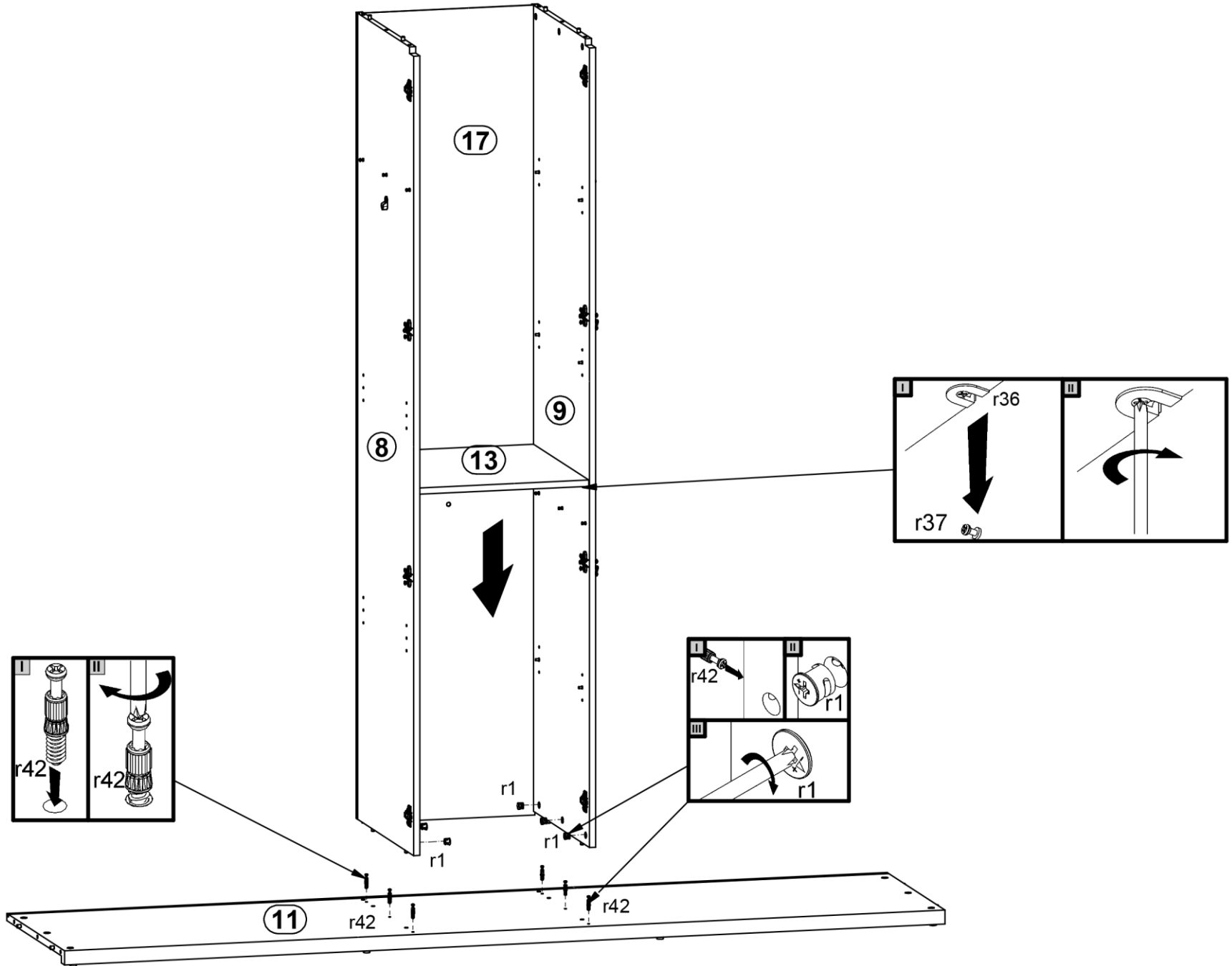

5

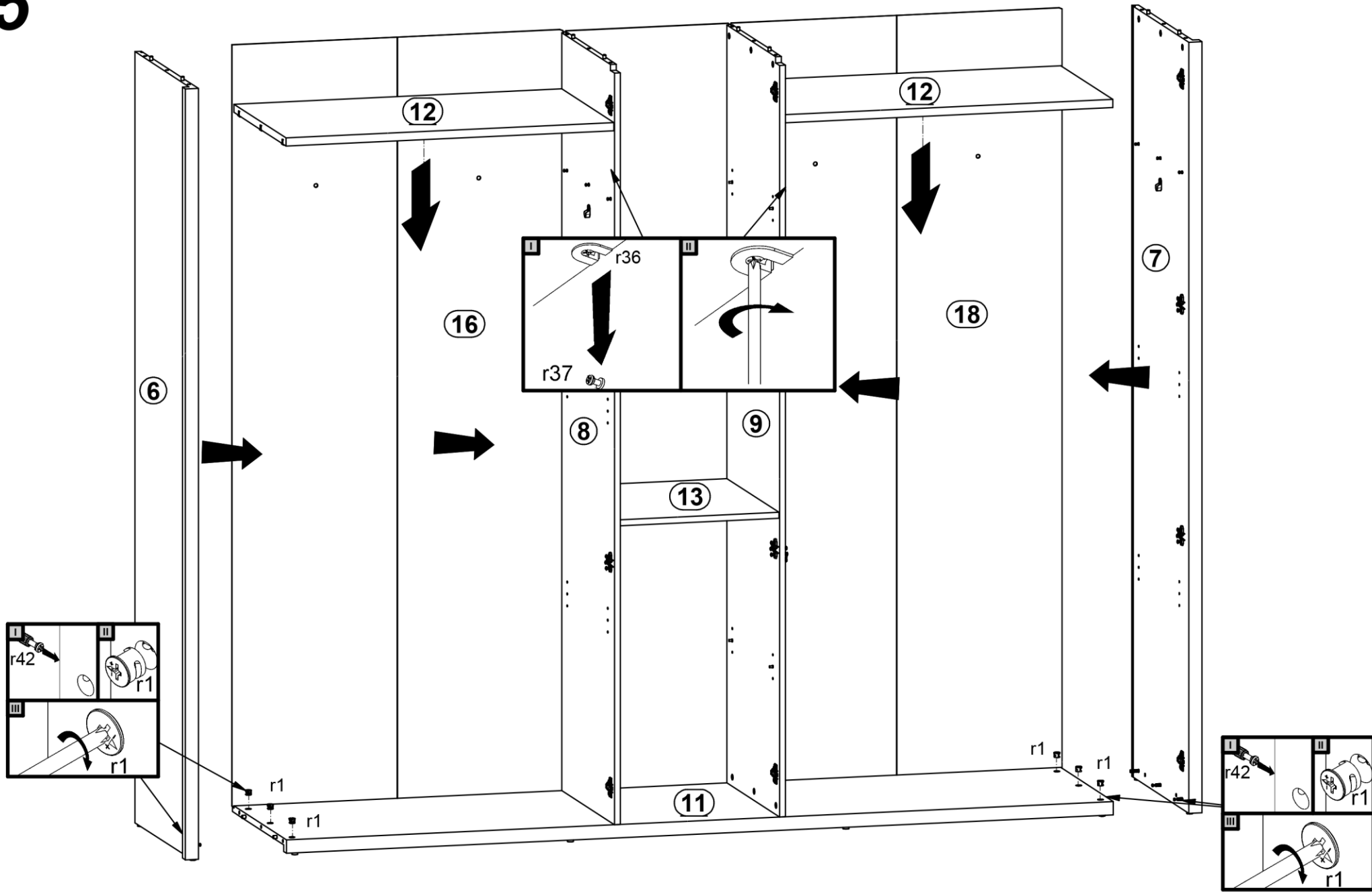

6

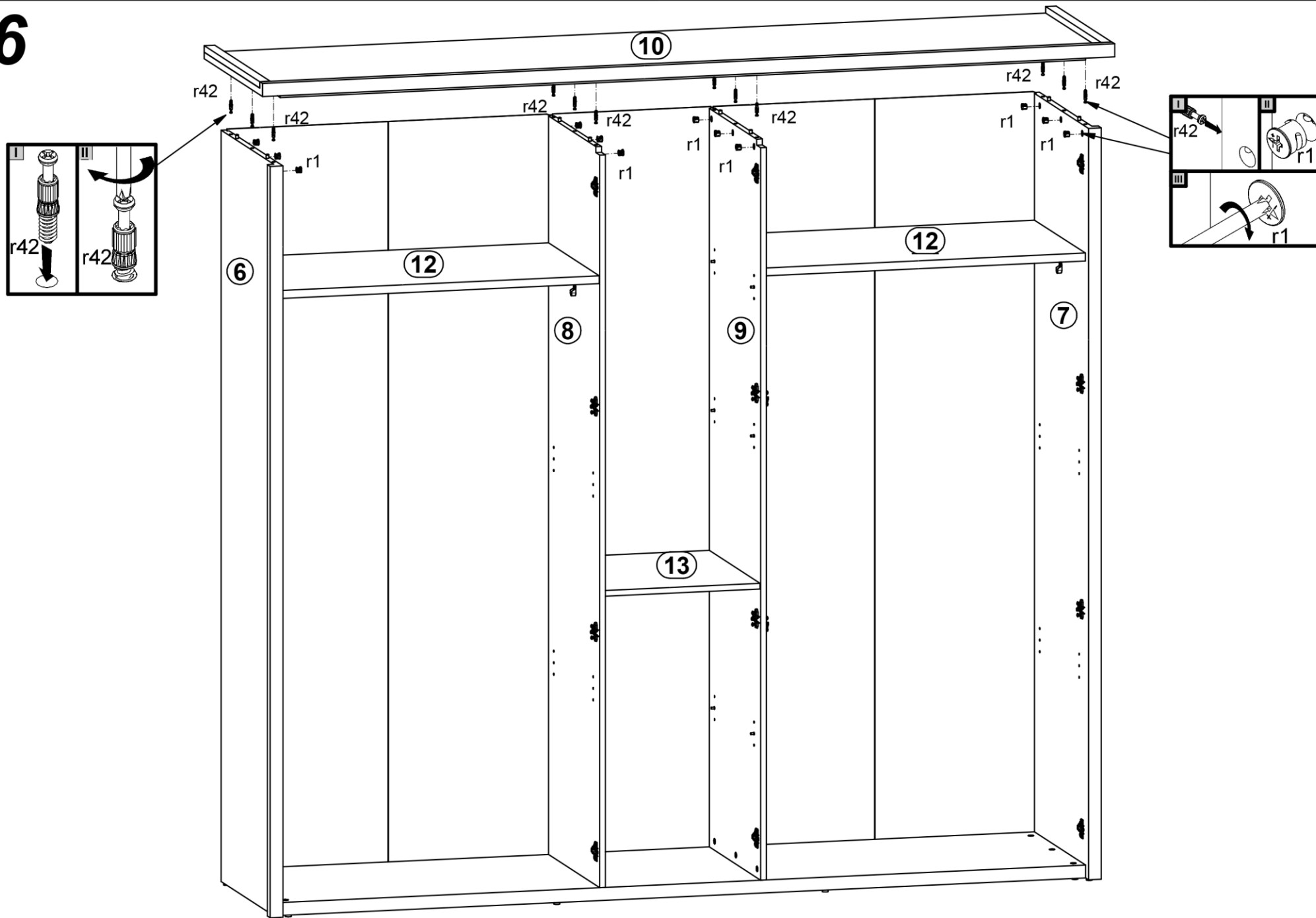

7

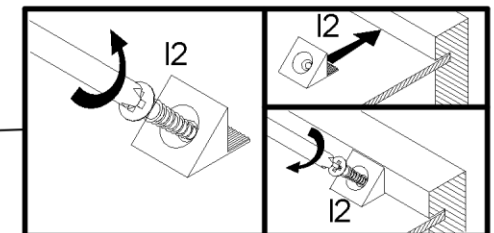
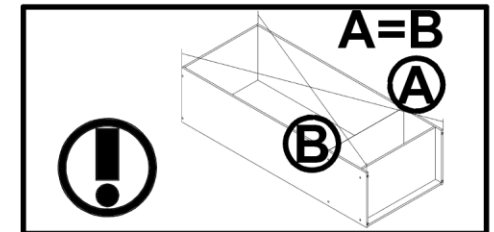
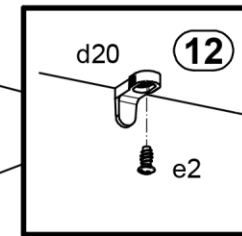
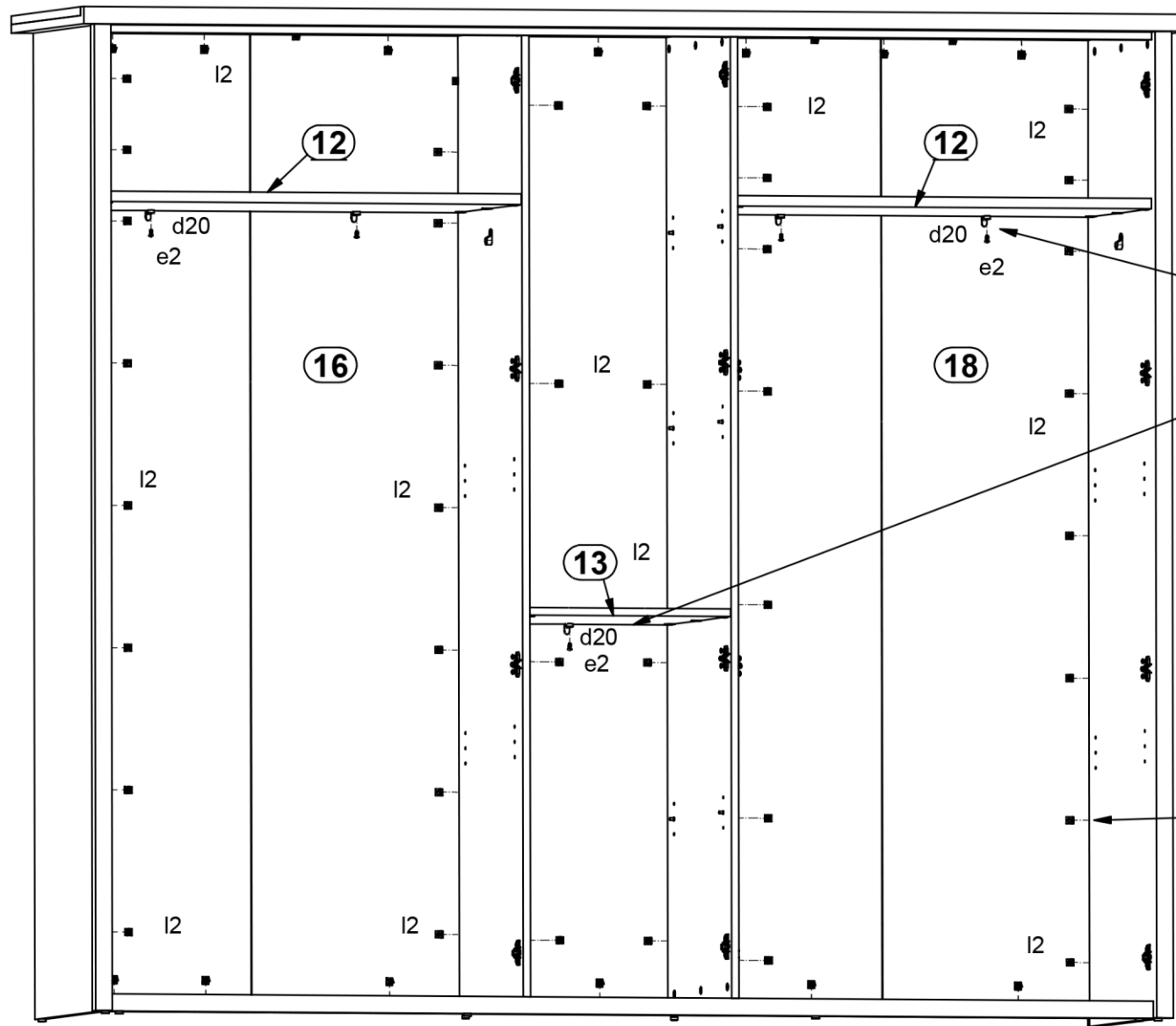

8 

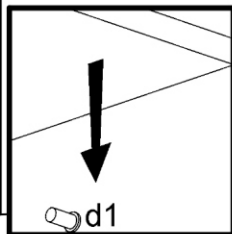
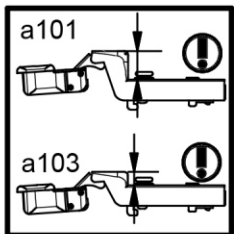
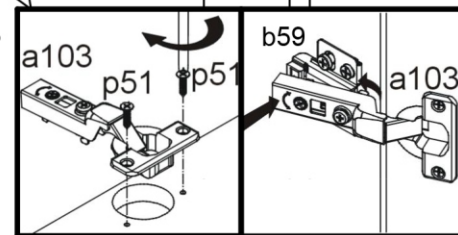
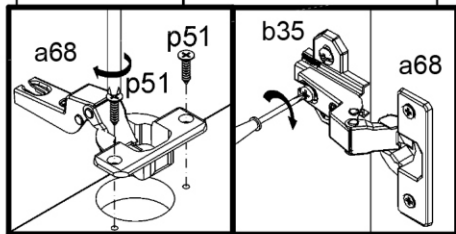
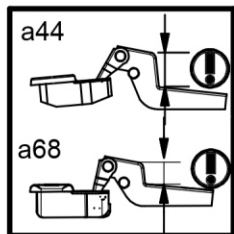
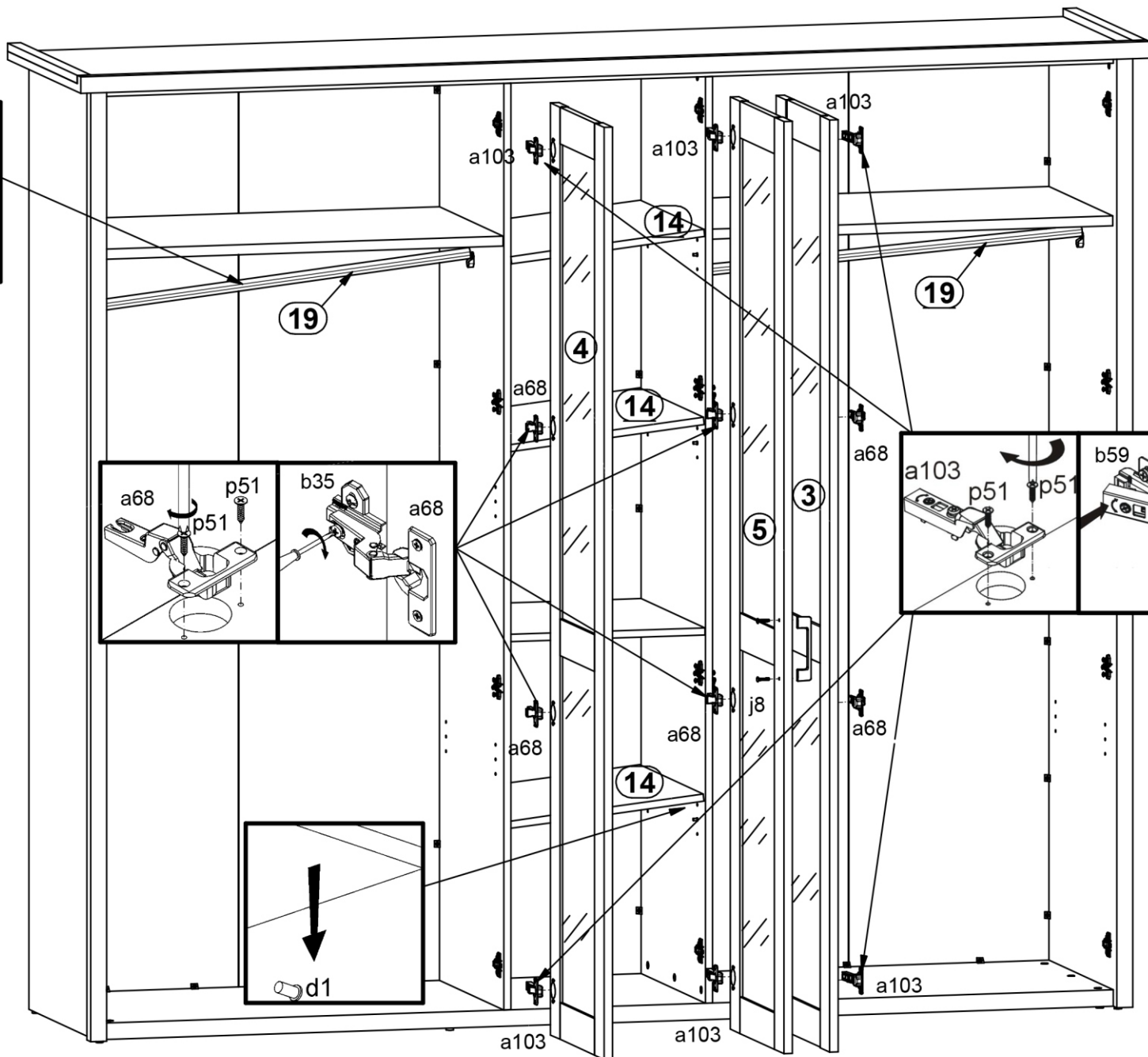
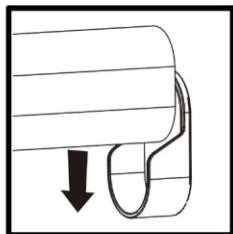

9

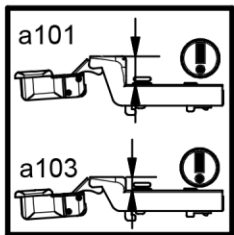
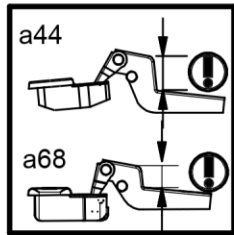
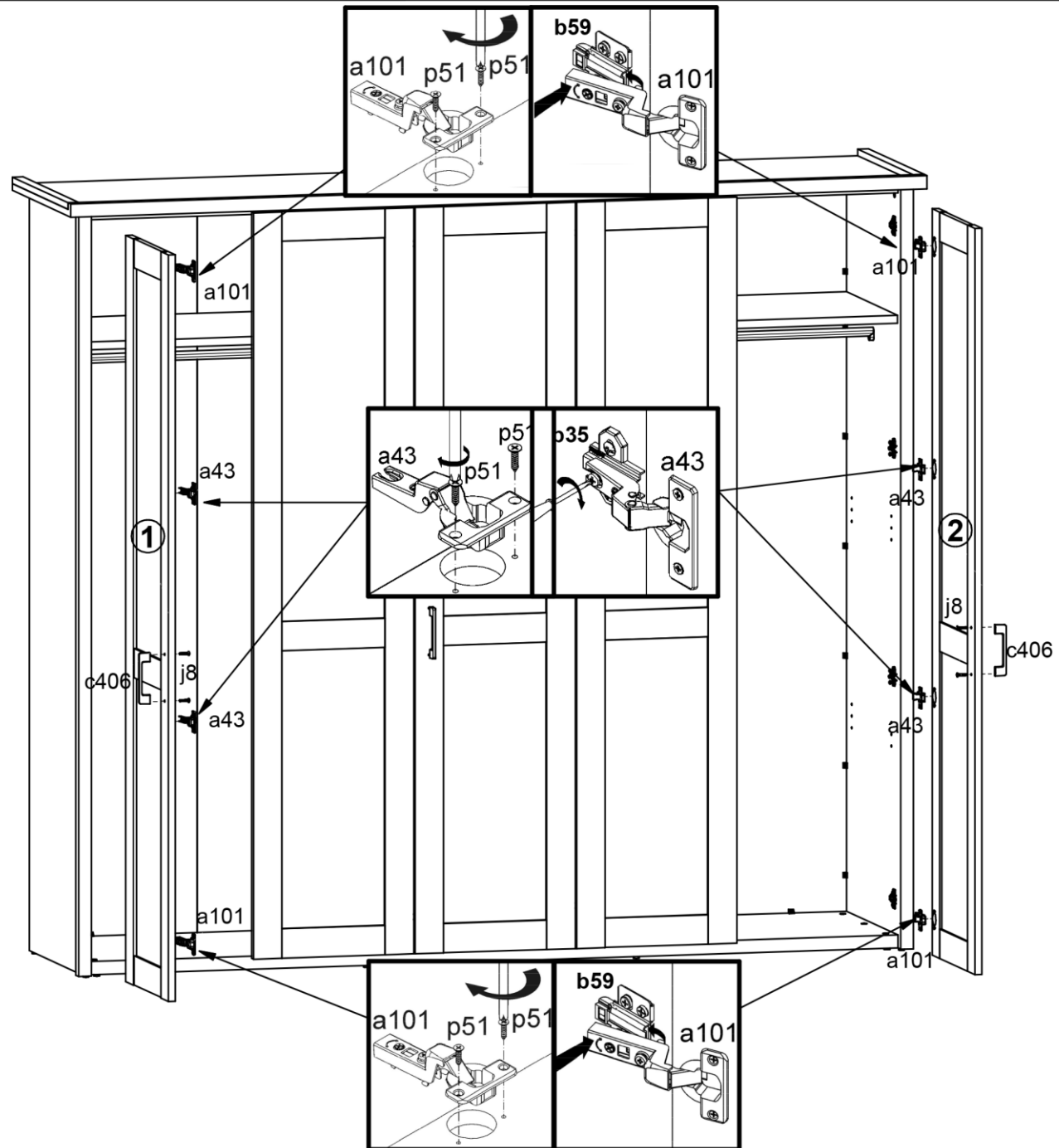

9

